



pulsar **N160**



THE WORLD'S
FAVOURITE
INDIAN

Owner's Manual



FOREWORD



Welcome to the Pulsar family! You are now the proud owner of the next generation **Pulsar N160 BS VI** India's No.1 sports bike. By No.1 we are talking about unparalleled performance, superior technology and incredible market leadership that Pulsar today enjoys. This makes the Pulsar you ride, unbeatable and unchallenged both on and off the road. Before you ride out, please read this Owner's Manual carefully and familiarize yourself with the operating mechanism, controls and maintenance requirements of your Pulsar. This will ensure you a safe and trouble free ownership experience. To keep your bike in perfect running condition and deliver consistent performance, we have specially programmed the periodic maintenance services which includes 3 free services and subsequent paid services, as per the schedule contained in this booklet. We earnestly advise you to avail all these services at any of our Bajaj Dealers, who are well equipped with all necessary facilities / genuine parts / oil and trained manpower to ensure the best care for your Pulsar. Your **Pulsar N160 BS VI** comes with a warranty of **5 Years or 75 000 Kms**, whichever occurs earlier from the date of sale. For details please refer to "Warranty : Scope and Limits" given in this manual.

Should you require any additional information feel free to contact us on helpline numbers or e-mail us at: customerservice@bajajauto.co.in or visit the Bajaj Auto website www.bajajauto.com To be a part of the Pulsarmania, visit www.mypulsar.com and join the Pulsar fanpage on facebook: www.facebook.com/mypulsar
Rev up, shift gears and enjoy the Pulsar experience...

**SERVICE DEPARTMENT
BAJAJ AUTO LIMITED**

TABLE OF CONTENTS



Description

1. Technical Specifications.....	1
2. Identification Data	4
3. Location of Parts	5
4. Steering cum Ignition lock	6
5. Fuel Tank Cap	7
6. Speedometer Details	8
7. Speedometer Setting	14
8. Control Switches	16
9. Pillion Seat / Tool kit	19
10. Rider Seat / Battery / Fitment Of Rider & Pillion Seat....	20
11. Antilock Braking System (ABS).....	21
12. Daily Safety Checks	22
13. How to ride your Bike	23
14. Safe Riding Tips	27
15. Engine Oil	28
16. Tubeless Tyre & Tyre Pressure	29
17. Battery.....	30
18. Periodic Maintenance Information	31
19. Brake Fluid	33
20. Free Service Guidelines	34
21. Periodic Maintenance & Lubrication Chart.....	35
22. Non Use Maintenance	43
23. Delivery Certificate	44
24. Warranty : Scope & Limit	45
25. Battery Warranty Card	48

Safety and Warning information :

Warning :



This indicates that a potential hazard or injury to you or other persons & to the vehicle can happen if advice provided is not followed.

Caution :



This indicates that a potential hazard that could result in vehicle damage. Follow the Advice provided with the caution.

Notice:

The description and illustration in this booklet are not to be taken as binding on the manufacturers. The essential features of the type described and illustrated herein remaining unaltered. Bajaj Auto Limited reserves the right to carry out at any moment without being obliged to bring this booklet upto-date & to do modifications on the vehicle, parts or accessories as may be convenient and necessary.

TECHNICAL SPECIFICATIONS



Parameter	Specifications
Engine	4 Stroke, Single Cylinder
Bore x Stroke	58 mm x 62.38 mm
Engine Displacement	164.82 cc
Compression Ratio	10.3 ± 0.3 :1
Idling Speed	1400 ± 100 RPM
Max. Net Power	16 PS at 8750 RPM
Max. Net Torque	14.65 Nm at 6750 RPM
Ignition System	DC
FI System	BOSCH
Spark Plug	2 Nos.
Spark Plug Gap	0.8 ~ 0.9 mm
Lubrication	Wet sump forced Lubrication
Transmission	5 speed constant mesh
Gear Shifting Pattern	1 Down 4 Up
Engine Cooling	Oil cooled
Starting Aid	Electric
Front & Rear Brake	Disc Brake

TECHNICAL SPECIFICATIONS



Parameter	Specifications
Fuel Tank Capacity	
Full	14 Liters (No Reserve)
Dimensions	
Length	1989 mm
Width	743 mm
Height	1050 mm
Wheel base	1358 mm
Ground Clearance	165 mm
Tyre & Tyre Pressure	
Front Tyre	100/80-17,52P Tubeless
Rear Tyre	130/70-17,62P Tubeless
Front	1.75 Kg/cm ² (25 PSI)
Rear (Solo)	2 Kg/cm ² (28 PSI)
Rear (with pillion)	2.25 Kg/cm ² (32 PSI)
Electrical System	12 Volts DC
Battery	12V 4Ah VRLA
Head Lamp	LED
Tail / Stop Lamp	LED
Side Indicator	Bulb Amber (4 Nos.)

TECHNICAL SPECIFICATIONS



Parameter	Specifications
Position Lamp	LED
Turn Signal Indicator	LED
Neutral Indicator	LED-Green
Hi-Beam Indicator	LED-Blue
Speedometer Illumination	LCD-Blue
Fuel Level Indicator	LCD Bars
Malfunction Indicator	LED-Yellow
Low Oil Pressure Indicator	LED-Red
Low Battery Indicator	LED-Red
REV Indicator	LED-Yellow
Service Reminder	LCD
Side Stand Indicator	LED-Red
ABS Indicator	LED-Yellow
Rear No. Plate Lamp	12V, 5W Bulb
Horn	12V DC
Vehicle Kerb Weight	153 kg. Single Channel ABS, 154 kg. Dual Channel ABS
Vehicle Gross Weight	303 kg. Single Channel ABS, 304 kg. Dual Channel ABS

Note : • All dimensions are under UNLADEN condition. • Above information is subject to change without any notice.

• This vehicle complies to BS VI standards. • AHO / DRL is government regulation.

IDENTIFICATION DATA

pulsar N160

The frame & Engine serial numbers are used to register the motorcycle. They are the unique Alpha-Numeric codes to identify your particular vehicle from others of the same model & type.



Frame Number Location

On RH Side of Steering Tube
(Alpha-Numeric - 17 Digits)

Engine Number Location

On LH Side Crankcase Near Change lever
(Alpha-Numeric - 11 Digits)



LOCATION OF PARTS

pulsar **N160**

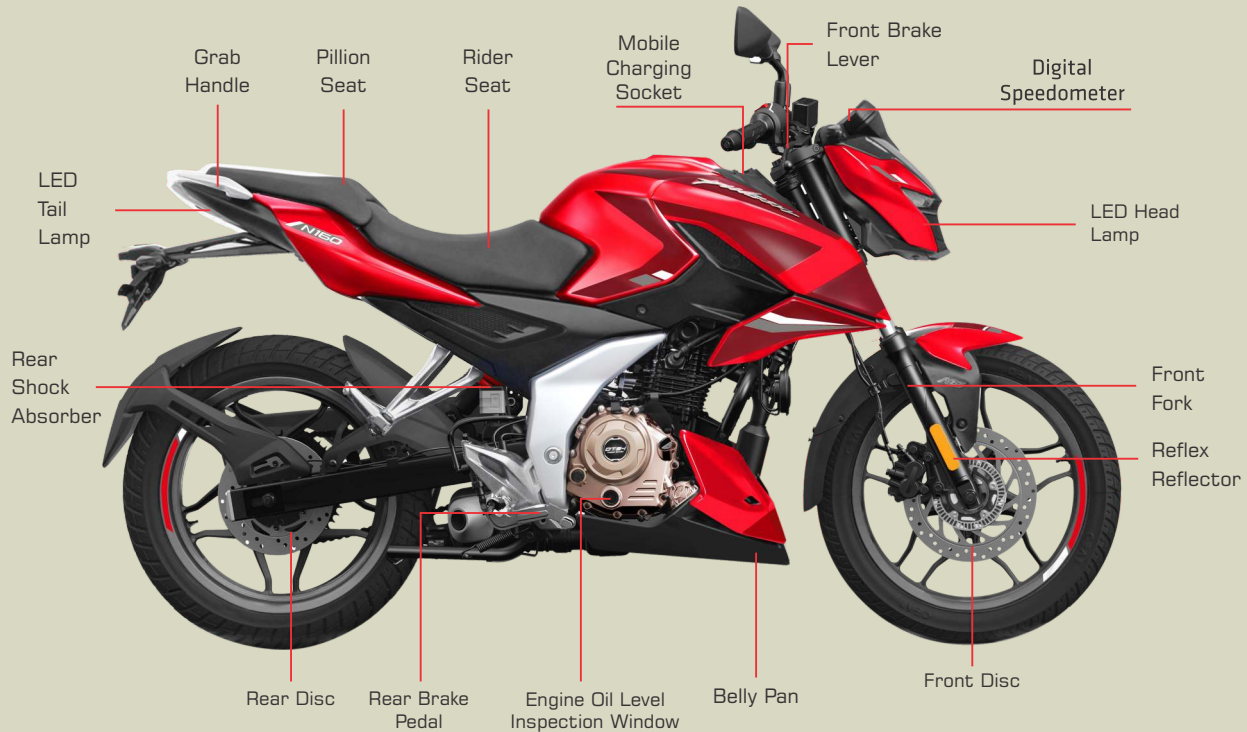

STEERING CUM IGNITION LOCK



Steering cum Ignition Lock :

It has three positions



- **Lock** : Steering locked. Ignition OFF.
- ⊗ **OFF** : Steering unlock. Ignition OFF.
- ⊙ **ON** : Steering unlock. Ignition ON.

To lock the steering :

Turn the handle bar to the left side. Push & Rotate the key to "LOCK" Position & Remove the key.

Steering locking on handle position left hand side only.

To Unlock the Steering: Insert the key in steering cum ignition lock. Push & Rotate it clockwise to "OFF" or "ON" position.

Key: A common key is used for 'Steering cum Ignition lock', 'Fuel tank cap' & 'Rear Seat'.

"Cranking ON and OFF duration" control:

- During Engine crank cycle cranking is allowed only for fixed duration and in between successive cranks (in case engine does not start) here is a cooling off period.
- Cranking on-off duration control feature to avoid battery discharge-
 - 1st Crank ON (5 sec) & Disable for 2 sec.
 - 2nd Crank ON (5 sec) & Disable for 2 sec.
 - 3rd Crank ON (5 sec) & Disable for 10 sec.After a gap of 10 sec cranking cycle continues.
- Headlight control on rpm – Headlamp will be turned ON only at Engine running condition.



Fuel Tank Cap

Fuel Tank Cap

- To open the fuel tank cap, open the flap. Insert the key in the lock & turn it clockwise & lift fuel tank cap.
- To lock the 'Fuel Tank Cap' insert the key in the lock and turn it clockwise and press fuel tank cap from top giving thumb pressure on top surface. 'Click' sound ensures cap is fully locked.

Cautions :

- While operating fuel tank cap do not give pressure on tank cap flap.
- Don't attach metallic 'Key Chain' as it may damage paint of petrol tank cover.

SOP to prevent fuel stains on petrol tank

- After petrol refilling & before shutting the cap wipe the spilled petrol from the painted areas around the cap by soft dry cotton cloth.
- Shut and lock the cap fully.
- This practice needs to be followed to maintain the shine of color on petrol tank.

Glossy Finish Painted Parts Cleaning

Do's:

- Use Colin or caustic free detergent solution for cleaning.(1 spoon in ½ bucket)
Remove foreign substances like insect remains, road debris using a soft brush.
- Use microfiber cleaning cloths Ex.- Muslin cloth for painted parts cleaning.
- Use recommended 3M polish.

Don'ts:

- Do not use products that are even mildly abrasive, such as polishes, glazes, or rubbing compounds.
- Do not use mechanical cleaners/polishers.
- Do not use terrycloth or paper towels or shine enhancement products.
- Do not rub the finish vigorously, this will burnish the paint finish, causing a permanent shiny spot. Shiny spots cannot be removed.

SPEEDOMETER DETAILS

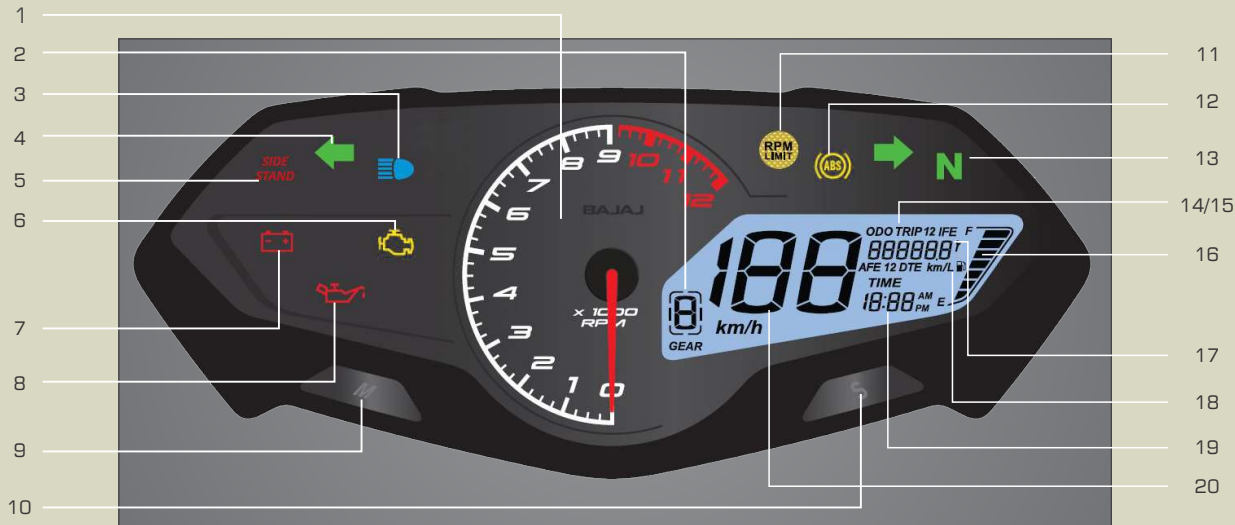

SPEEDOMETER DETAILS



Speedometer display will work when Ignition switch is in 'ON' position.

- 1. Tachometer Dial:** It shows engine speed in RPM.
- 2. Gear Indication (G):** It will display gear position from 1 to 5. It will display 0 when vehicle is in neutral position.
- 3. High Beam Indicator (H):** It glows when Headlight is ON & High beam is selected with engine running.
- 4. Turn Signal Indicator (L/R):** When Turn signal switch is pushed to Left or Right, Turn Signal Indicator - LH or RH will flash.
- 5. Side Stand Indicator:** It glows when side stand is down

Side Stand Condition	Gear position	Remark
Down	Engine in neutral gear position	Self-start / kick start possible
	Shifting gear from 'N' to 1st gear in engine start condition by pressing clutch lever	Engine will get cut off
Down	Engine in gear position	Engine will not start by self-start / kick start.

- 6. Malfunction Indicator (M):** It glows whenever any abnormality is noticed in functioning of FI system related components.
- 7. Low Battery Indicator (B):** It indicates battery needs charging.
- 8. Low Oil Pressure Indicator (O):** It glows when engine oil pressure is low.
- 9. Mode Button:** Mode button used for toggling between different modes e.g. ODO, Trip1, Trip2, DTE and clock setting.

10. Set Button: Set button used for toggling between ODO to IFE, Trip1 to AFE1, Trip2 to AFE2, DTE to distance to next service and clock setting.

11. Engine REV Indicator: (R) It glows when engine RPM exceed 9000 RPM. It indicates customer "Not to REV up engine beyond safe engine operating RPM.

12. ABS Indicator (ABS): With Ignition switch ON the ABS indicator glows. When vehicle speed is more than 5 Km/h the ABS indicator goes off, if this indicator glows while vehicle is running, it means there is problem in ABS.

13. Neutral Indicator: (N) When the transmission is in Neutral, Neutral indicator will glow.

14. Odometer: The Odometer shows the total distance that the vehicle has covered. Odometer can not be reset to 'Zero'.

15. Trip Meter: Selected Trip meter shows the distance traveled since it was last reset to zero. Both trip meters can be reset to zero by pressing the Set button. After completion of max value of 999.9 Km, selected trip display will get freezed and will not get set automatically to zero.

16. Fuel Level Indicator: (F) It shows available fuel in fuel tank.

SPEEDOMETER DETAILS



17. **Service Reminder (wrench icon):** 'Wrench' symbol glows when ODO meter reading reaches to set Kms. It indicates vehicle is due for periodic service.

This Icon will flash at -

1st : 450 km 2nd : 4450 km,

3rd : 9450 km 4th : 14450 km

and subsequently at each 5000 kms. Icon will continue to glow till it is reset. This icon is to be reset after service is carried out. Service reminder reset is to be done at zero vehicle speed & zero engine speed.

18. **Low Fuel Level Indicator:** (fuel gauge icon) It blinks incase of low fuel level (1 bar or less)

19. **Digital Clock:** It indicates time in HR: MM (AM/PM)

20. **Speedometer:** Vehicle speed will be displayed in digital form in Km/h

Note :

After switching 'ON' the ignition switch, the following indications will remain 'ON' till engine is started.

- Low Battery Indicator
- Low Oil Pressure
- Malfunction Indicator

Instructions :

Incase Low battery indicator, Low oil pressure indicator, Malfunction indicator, ABS indicator gets ON during vehicle running, bring the vehicle to nearest BAL authorised workshop for inspection/ repair.

DETAILS - IFE & ODO

pulsar N160



Condition

Ignition switch is ON & Set push button not pressed. Following display will be shown by digital speedometer.

1. **IFE (Instantaneous Fuel economy):** This will indicate fuel economy in km/L. at any given time. Value will be displayed only when vehicle speed & Engine RPM is more than zero.
If vehicle speed is zero then IFE will be displayed "--km/L"
2. **ODO:** The Odometer shows the total distance that the vehicle has travelled.

3. **Fuel Level Indicator:** Fuel level is shown by digital LCD bars with (E) empty, (F) full & (🛢️) fuel tank LCD symbol.
Low fuel level icon blinks if number of bars on the fuel gauge are less than 2 bars.

Note:

IFE (Instantaneous fuel economy) / AFE (Average fuel economy) / DTE (Distance to empty) readings are indicative & may vary due to driving and road conditions.



Procedure to set AFE1 & TRIP1:

Ignition switch is ON & Set push button pressed for less than 1 sec. - TRIP1 mode gets selected & following display will be shown by digital speedometer

1. **AFE1 (Average Fuel economy1):** This will indicate the average fuel economy in km/L in TRIP1 mode.
2. **TRIP1:** The Trip meter shows the total distance that the vehicle has travelled in TRIP1 mode. If TRIP1 is reset, average fuel economy (AFE1) will reset.

Procedure to set AFE2 & TRIP2:

Ignition switch is ON & Set push button pressed for less than 1 sec. - TRIP2 mode gets selected & following display will be shown by digital speedometer

3. **AFE2 (Average Fuel economy2):** This will indicate the average fuel economy in km/L. in TRIP2 mode.
4. **TRIP2:** The Trip meter shows the total distance that the vehicle has travelled in TRIP2 mode. If TRIP2 is reset, average fuel economy (AFE2) will reset.

Note: AFE will be updated every 60 sec. AFE will be reset if corresponding TRIP1 or TRIP 2 is reset or battery disconnected.

DTE (Distance to empty):

It indicates the estimated distance that the vehicle can travel under current fuel economy & fuel level condition.

DTE calculation is independent of TRIP and based on AFE for distance covered for last 25 Kms.

Max count of DTE is 990 Km. speedometer will display values in multiple of 10.



TRIP Setting:

If Set button is pressed more than 3 sec.in TRIP1 or TRIP 2 mode, then respective AFE & trip distance will reset to Zero while DTE will continue to show earlier value.

Note:

After completion of max value of 999.9 Km, selected trip display will get frozen and will not get set automatically to zero.

However speedometer will continue to calculate and display AFE value.

Note:

If vehicle is driven by ignoring fuel level display & Tank symbol () blinking after reaching fuel unutilized level DTE will be shown as '--' Km.

During Petrol Refilling:

If petrol filled is more than 1 Liter then DTE will be calculated based on the revised fuel volume.

If petrol filled less than 1 Liter then there will be no change in DTE value.

SPEEDOMETER SETTING

pulsar N160



1. Trim Meter Reset:

Mode & set push button is provided for selecting & resetting "ODO/ TRIP1/TRIP2/ Distance to next service".

1. Press mode button for less than 1 sec.
2. Press set push button for more than 3 sec.

Mode changes from "ODO/ TRIP1/TRIP2/ Distance to next service.

Selected TRIP1/ TRIP2' will reset. Other TRIP mode will continue updating.

2. Service Reminder Reset (🔧): 'Wrench' symbol glows when ODO meter reading reached to set Kms.

This icon will glow at-

- 1st : 450 Kms
 - 2nd: 4450 Kms
 - 3rd: 9450 Kms
 - 4th: 14450 Kms
- & subsequently at each 5000 Kms.

Note: Bring the motorcycle at authorised BAL dealership for re-setting the service reminder icon.



3. Clock Reset:

- Digital clock indicates time in HR & MM separated by colon ':' It is 12 hour clock.
- For entering clock setting mode - press mode & set button together for 3 sec.
- Initially ':' will be blinking.
- Clock setting is possible in TRIP 1 mode only.

Press mode & set button together for more than 3 sec.	':' stops blinking Digits HH starts blinking.
Press mode button for less than 1 sec	Hour digits will increase.
Press set button for 1 sec.	HH value will be stored while MM starts blinking.
Press mode button for 1 sec.	Minute digits will increase.
Press set button for 1 sec.	HH and MM value will be stored & AM starts blinking
Press mode & set button together for more than 2 sec.	Set value will be saved Exit clock setting mode Digits stop blinking ':' start blinking.
Clock set mode is selected & no ending is carried out for more than 5 sec,	Auto exit without saving set value. If engine / vehicle rpm is given then system will exit from clock set mode without saving set value.

Mobile Charger

- Mobile charging socket has been provided on fuel tank cover
- The charger socket has been provided with cap to protect charger socket from dust & water entry during washing / during rain.
- Always ensure charger cap is firmly fitted on socket when charger socket is not in use.



- The mobile charger will supply output voltage only in engine running condition.
- Customer to use suitable USB cable for mobile charging.







Caution:

Do not use mobile phone while driving. Momentary lapse in concentration might result in an accident.

CONTROL SWITCH - LH

pulsar N160



- A. **High/Low Beam Switch:** When headlight is ON, High or Low beam can be selected with this switch. Hi beam indicator light located on Speedo console will light up when high beam is selected.
: High Beam  : Low beam 
- B. **Turn Signal Switch:** When the turn signal knob is turned to Left () or Right () respective indicator will start blinking, to stop blinking push the knob in & release.
- C. **Horn Button** (): Press button for sounding horn.

D. Pass Switch : Press the switch to put 'ON' Hi Beam. It is used to give signal to vehicles coming from opposite side while overtaking.

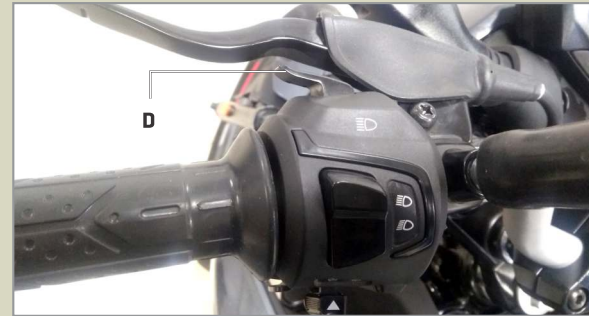

CONTROL SWITCH RH - AHO





Applicable for N160 single channel ABS vehicles

E. Starter Button:

Starter button operates the electric starter. It is recommended to start the engine with the transmission in neutral. Vehicle in Gear - Press clutch lever & operate starter button to start the engine.

F. Engine Kill Switch:

The engine kill switch is used for switching ON & OFF the engine. :

-  : Engine OFF
-  : Engine ON



AHO (Automatic Headlight 'ON')

There is no 'Light Switch' on RH control switch.

Ignition switch 'ON' Engine 'OFF'	Speedometer illumination will get 'ON'
Effect of pressing 'Pass switch'	In addition to above Hi-beam will get 'ON' & high beam indicator will get ON

Ignition switch 'ON' & Engine Running

Speedometer illumination, tail lamp, number plate lamp, pilot lamp will get 'ON' in addition to above, head lamp will get ON as given below

Hi/Low Beam switch	Head Lamp Beam Status	Effect to Pass Switch
Low Beam 	Low Beam 'ON'	Hi Beam 'ON'
Hi beam 	Hi beam 'ON'	No change

CONTROL SWITCH RH - DRL

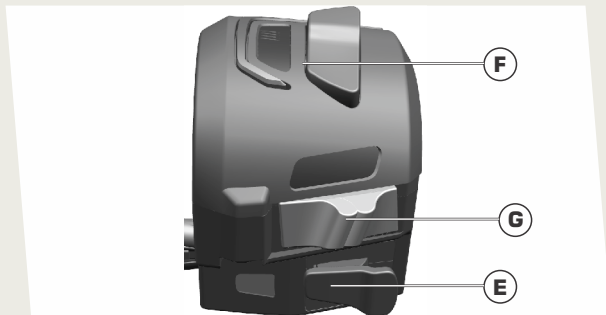

Applicable for N160 Dual channel ABS vehicles

E. Starter Button:

Starter button operates the electric starter. It is recommended to start the engine with the transmission in neutral.

Vehicle in Gear - Press clutch lever & operate starter button to start the engine.

F. Engine Kill Switch:

The engine kill switch is used for switching ON & OFF the engine. :

☒ : Engine OFF

☑ : Engine ON

G. Light Switch: It has 2 positions. When ignition switch is 'ON', lighting system will work as per given table.

● : Tail lamp will get 'ON'. DRL 'ON' (High Intensity)

☀ : Head lamp, Tail lamp, Number Plate lamp & Speedometer illumination will get 'ON'. DRL remains 'ON' (Low intensity)

Day Time Running Light Feature:

- Day Time Running light is provided inside headlamp.
- Day Time running light gets 'ON' (High intensity) when ignition switch turned to 'ON' position.
- After headlight is turned to 'ON' position with **engine running** intensity of DRL LED's will get reduced.

Ignition Switch	Light Switch	DRL	Head Light
ON	OFF	ON High Intensity	OFF
ON	ON	ON Low Intensity	ON



Removal of Pillion Seat

- Insert Key into lock (A).
- Turn the key clock wise.
- Lift front end of 'Pillion seat'
- Pull 'Pillion seat' toward front side.
- Take out 'Pillion seat'.

First Aid kit Location

- It is located on RH side of Seat Cowl below the 'Pillion seat'



Tool Kit Location

- Screw driver is kept in seat cowl RH as shown in photograph. Spanner is kept in rider seat & fitted with tie band as shown in photograph.



Removal of Rider Seat

- First remove 'Pillion seat'.
- Lift & pull backward rear end of 'Rider Seat'.
- Take out 'Rider seat'.

Battery

- It is located below rider seat.

Fitment of 'Rider Seat'

- Match the mating part (A) of 'Rider seat' with slot (B).
- Push 'Rider seat' towards petrol tank.
- Match 'Rider seat' rear Lugs (C) with the holes (D) provided on chassis.

Fitment of 'Pillion Seat'

- First make sure 'Rider seat' is fitted properly.
- Match the bracket of 'Pillion seat' (H) with Hook (I).
- Insert lock rod (F) of seat into hook (G).
- Press front portion of seat.

ANTILOCK BRAKING SYSTEM (ABS)



- Single Channel / dual channel ABS System is fitted in these vehicles
- Single Channel ABS means ABS is fitted on Front wheel Only. Dual channel ABS means ABS is fitted on front & rear wheels
- Always maintain a safe distance between you and objects ahead. Vehicle speeds should always be reduced during extreme road conditions. The braking distance for motorcycle equipped with an anti-lock braking system may be longer than for those without it on rough road conditions. During these conditions the vehicle should be driven at reduced speeds
- When you apply Front brake / Rear brake by pressing Front brake lever/Rear brake pedal under conditions which may lock the wheels, you feel a corresponding sensation (pulsation) in Front brake lever/ Rear brake pedal. (as applicable to model) This is normal and it means ABS is active.
- Also it is recommended to use both front and rear brakes simultaneously.
- Always slow down when cornering. The anti-lock brake system cannot prevent accidents resulting from excessive speeds.
- Never drive by disconnecting wheel speedometer cable.

Before riding motorcycle be sure to check following items. Please give proper importance to these checks and perform all of them before riding motorcycle. If any irregularities are found during these checks, refer to the Maintenance chapter & see your dealer for the action required to return the motorcycle to a safe operating condition.

⚠ Warning: Failure to perform these checks every day before you ride may result in serious damage or severe accident.

- Enough **fuel level** for planned distance of journey. No fuel leakage in fuel lines.
- **Engine oil** level (between upper and lower level mark)
- **Throttle cable** play of 2 - 3 mm. Smooth operation and positive return to closed position,
- **Brake Fluid** level above MIN mark provided on Front & rear reservoir
- **Drive Chain** slack of 20-30 mm adequately lubricated. • Function of all lights & horn
- **Clutch lever** play - 2 to 3 mm
- Smooth **steering movement** without restriction.
- **Side stand** return to It's fully up position.

- Correct **inflation pressure** in both tyres. Adequate tyre tread depth - no cracks / cuts.
- Correct **rear viewing** span adjustment of mirror.
- Cleaning cloth not to be kept in vicinity of high temperature zone e.g. Oil cooler, engine, silencer assembly, starter motor etc.
- Cleaning cloth to be kept in LH/RH seat cowl.

Instructions for Customer

- There is no fuel cock.
- Always maintain minimum 3 Liters petrol in fuel tank.
- Don't use fuel additives as it will result in rusting & clogging of Injector, Fuel pump module & catalytic convertor.
- If vehicle is tilted beyond 60 Deg, then Roll over sensor cuts off Ignition system as a safety feature.
- Never drive by disconnecting wheel speed sensor as ABS unit will not function.

1. Starting The Engine:

- Ensure minimum 3 liters petrol is available in fuel tank.
- Turn ignition switch key to 'ⓐ' position.
- Put kill switch in 'ⓐ' position.
- Confirm that transmission is in neutral / press the clutch lever if transmission is in gear.
- Keep throttle closed & press starter button,
- Release starter button as soon as engine starts.

“Cranking ON and OFF duration” control –

Cranking ON-OFF duration control feature to avoid battery discharge-

- 1st Crank ON (5 sec) & Disable for 2 sec.
- 2nd Crank ON (5 sec) & Disable for 2 sec.
- 3rd Crank ON (5 sec) & Disable for 10 sec. After a gap of 10 sec cranking cycle continues.

Note:

- The motorcycle is equipped with a clutch switch. This switch facilitates engine starting in neutral and gear position.

Gear Position	Clutch lever position
Neutral	Released
Gear	Fully pressed

- In case of battery discharged condition please bring the vehicle to bajaj authorised workshop for repairs.

2. Shifting Gears:

- Close throttle and depress the clutch lever fully.
- Shift into next higher or lower gear.



Gear shifting Lever



Gear Shifting Pattern

3. Moving Off:

- Check that side stand is up.
- Depress the clutch lever.
- Shift into 1st gear.
- Open the throttle and release the clutch lever slowly and simultaneously.
- As the clutch starts to engage, open the throttle a little more, giving the engine just enough rpm to keep it from stalling.

Recommended Speed for Shifting Down

From 5th to 4th Gear	57 km/h
From 4th to 3rd Gear	45 km/h
From 3rd to 2nd Gear	33 km/h
From 2nd to 1st Gear	17 km/h

⚠ Warning: When shifting down to lower gear, do not shift at such high speed that engine rpm jumps excessively. This may cause engine damage, & rear wheel may skid. Downshifting should be done at recommended speeds as shown in table above.

4. Braking & Stopping the Vehicle:

- Close the throttle completely, leaving the clutch engaged (except where shifting gears) so that the engine braking will help slow down the motorcycle.
- Shift down one gear at a time so that you are in Neutral when you come to a complete stop.
- When stopping, always apply both brakes at the same time.

5. Parking Using Side Stand:

- Support the motorcycle on a firm level surface with the side stand.
- Lock the steering on LHS.

Caution: Do not park on a soft or steeply inclined surface as the motorcycle may fall over.



E20

- This vehicle is compatible for "E20" Petrol i.e. Petrol blended with 20% Ethanol. E20 sticker affixed on fuel tank cap.
- In this vehicle 'E10' Petrol (existing) i.e. Petrol blended with 10% Ethanol also can be filled.

Whenever vehicle is fallen down, remove plug of 'Y' connector drain tube & drain out accumulated petrol.

7. Running IN

Proper running-in is important for the better life & trouble free performance of the vehicle.

- During first 2000 kms running-in period do not exceed following speed limits.

Kms	1st	2nd	3rd	4th	5th
0-1000	10	20	30	40	50
1000-2000	20	30	40	50	60

- Always keep speed below the limits given in table.
- Do not race the engine excessively.
- Do not start moving or race the engine immediately after starting. Run the engine for a minute at idle speed to give the oil a chance to work up into the engine.

CAUTION

Always ensure side stand is UP while starting off. Under condition-side stand down & vehicle is in gear, self start will be disabled. 'side stand' Indication will be displayed in speedometer.

- Do Not REV engine in standstill condition.
- Always maintain engine oil between MIN & MAX mark at vehicle upright position on level surface.
- Always maintain Brake Fluid is above MIN mark at on front & rear brake reservoir keeping vehicle upright position on level surface.

LED Headlamp Condensation:

Condensation inside headlamp is a natural phenomenon.

Condensation occurs when atmospheric air containing water vapor or humidity enters the headlamp through the vents due to temperature difference. A thin film of fog can form on the inside surface of the headlamp lens. The thin fog will clear and exit through the vents during normal operating condition.

Condensation & fogging of headlamp lens may happen during rain or after washing. Moisture condensation inside the headlamp lens will disappear gradually by switching ON the headlamp in high beam and driving the vehicle at 30 to 40 Km/h speed for about 15 minutes. Time for evaporation will vary depending on the humidity of the ambient air.

Ensure following maintenance points to get optimum performance from your bike.

Fuel	Always maintain minimum 3 Liter Petrol in fuel tank.
Spark Plugs	Inspect and clean spark plugs. Adjust electrode gap. Replace spark plugs as per P.M. Chart.
Air Filter	Replace as per Periodic Maintenance Chart.
Engine Oil	Check engine oil level. Always use recommended grade and quantity.
Brakes	Ensure that the brakes are not dragging / binding.
Clutch	Ensure correct clutch lever play.
Tyre Air Pressure	Always maintain recommended tyre pressure.
Brake Fluid	Always maintain brake fluid level above minimum mark. Ensure no leakage of brake fluid in brake system.

Fuel Saving Tips:

A well maintained vehicle and good driving can contribute a lot to the saving of petrol. Following are a few simple fuel saving tips.

- Avoid harsh braking.
- Change the gear judiciously according to the speed and load requirement.
- Don't overload the vehicle above the specified payload.
- Use the accelerator judiciously.
- Cut off the engine if you want to stop for more than two minutes.

How to check mileage (Fuel efficiency)

Best way to calculate mileage is by following the full tank to full tank method.

- Fill fuel tank up to small mouth (brim).
- Run the bike for say 100 km.
- Fill the tank again up to small mouth (brim). In same fuel filling station, probably with same fuel dispenser.
- Divide kilometer run / fuel quantity filled.

SAFE RIDING TIPS



- Always wear Helmet while driving or riding. Your helmet should conform to Indian standards.
- Read thoroughly the instructions given in this manual and follow them carefully.
- Avoid unnecessary accessories for the safety of both rider and other motorists.
- Familiarise yourself well with starting, acceleration and braking of the vehicle.
- When applying the brakes, use both front & rear brakes simultaneously. Applying only one brake may cause the vehicle to lose control.
- Riding at proper speed, avoiding unnecessary acceleration and braking are important safety, fuel consumption and longer life of the vehicle.
- During monsoon, drive vehicle more cautiously. Remember vehicle skid more easily during light showers.
- Keep both hands firmly on handle bar & both feet securely on rider footrest. Do not take away both hands & / or feet from resting area as this is very unsafe.
- Do not use mobile phones while riding as it could lead to fatal accident.
- It is suggested to customer to take appropriate care in area of heavy monsoon or high rainfall area. The appropriate surface preventive coat to avoid rusting / poor surface finish on account of adverse atmospheric conditions.
- Always carry vehicle registration & insurance papers, and a valid driving licence with you.

General Maintenance Tips:

- Vehicle cleaning to be done with soft & clean wet cloth to avoid scratches on painted parts.
- Clean & lubricate all the important parts as detailed in a periodic maintenance chart.
- Do not apply direct water jet on electrical / electronic parts.
- Do not obstruct engine cooling by adding mud protection sheet from front
- Drive cautiously. Start early & reach your destination safely.
- Avoid driving on loose sand or stones where vehicle is likely to skid.
- Properly wrap-up loose clothes while driving or riding to avoid entangling in wheel or other objects on road.
- Always concentrate on riding for safety.

ENGINE OIL

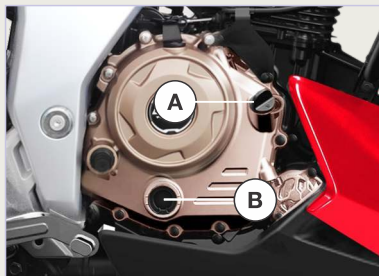

A : Oil Filler Cap
B : Oil Level Gauge

Engine Oil Level Checking:

- Check engine oil level every day. Park vehicle on center stand on level surface.
- Check oil level through oil level gauge 'B'.
- Always maintain engine oil level between upper and lower mark provided on Cover RH. Top up with specified grade of oil if the oil level is below lower level mark.

Engine Oil Capacity:

- Refill at servicing : 1250 ml
- During engine overhaul : 1450 ml

Recommended Engine Oil:

Always insist on Bajaj DTS-i Engine Oil for optimum engine performance and warranty benefits. It is a specially formulated oil for vehicles with DTS-i engines.

Model	Recommended Engine oil
Pulsar N160	Bajaj DTS-i 10W40 BS6 Compliant SAE 10W40 JASO 'MA2' API SN

- **Engine oil replacement frequency : 1st service & then every 10,000 Km.**
- **Engine oil level top-up frequency : Every 5000 km.**

Caution:

- It is most important to adhere to recommended grade and frequency of oil change for the purpose of long life of critical engine components. For details refer periodic maintenance chart.

TUBELESS TYRE & TYRE PRESSURE



Tubeless Tyre:

The main advantage of tubeless tyres is in case of puncture the rate of air leak is very slow, hence customer can easily drive the vehicle upto nearest puncture repair shop for removing puncture.



Wheel Puncture:

- Visit nearest known tubeless tyre repair shop to remove puncture.
- Remove puncture by Filler or Plug method only.
- Do not use patch method to remove puncture of tubeless tyre.

⚠ **Caution:** Tubeless tyres are fitted in this motorcycle. The walls of the tyres in contact with the wheel rim should not be damaged in any way during fitment / removal of tyre. The tyre side walls in contact with wheel rim seals air.

Tyre Pressure:

Keep appropriate tyre pressure as mentioned below to increase life of the tyre & for better fuel consumption.

Model	Front Tyre	Rear Tyre
Pulsar N160	25 PSI	28 PSI (Solo) 32 PSI with Pillion

- Tyre warranty is settled by tyre manufacturer.
- Decision is taken based on tyre wear & running of vehicle.
- BAL settles tyre warranty for only imported tyres.



Battery : 12V - 4 Ah VRLA

- Battery is located below Pillion Seat.

Battery Features:

- No topping-up is required
- Reduced self discharge, Enhance safety.
- No vent tube open to atmosphere hence no discharge of electrolyte through vent tube.

⚠ Caution:

Vehicle will not start if battery is discharged or disconnected from vehicle

- Environment care must be taken to dispose off the used battery.
- It is always recommended to hand over the same to the Authorised battery / BAL dealer for proper disposal of the same.
- When 'Low battery icon' pop-up in speedometer display, it is advised to reach Authorised battery / BAL dealer & get it charged immediately.
- Warranty on battery is 18 months from the date of purchase of vehicle.

How to keep battery healthy ?

- Switch 'Off' ignition when engine is not running.
- Get battery checked/ charged during periodic services.
- Do not add extra electrical accessories such as - Remote, Bigger Horn, Musical brake light etc. This will reduce life of battery & may damage ECU.
- Disconnect battery +ve & -ve wires if vehicle is to be stored for more than 2 weeks. This avoids self discharge.

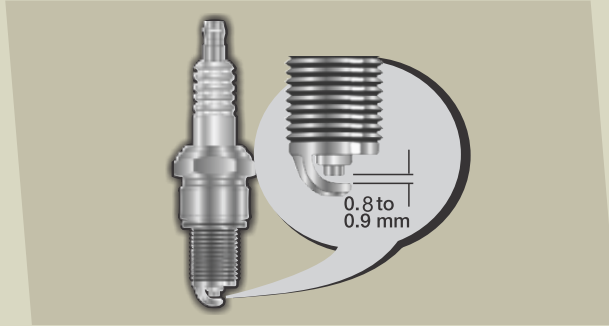

Spark Plug

- Remove spark plugs by using plug spanner.
- Clean the spark plugs.
- Adjust the gaps if incorrect by bending outer electrode carefully. Spark Plug Gap :0.8 to 0.9 mm.

Drive Chain Slackness

- Chain slackness will have to be adjusted whenever required.
- Std. Chain slackness 20-30 mm in 1st gear or both wheels touching to ground.
- Marking on chain adjusters should be identically positioned on both sides.





**Drive Chain
Cleaning**



**Drive Chain
Lubrication**

Drive chain must be cleaned & lubricated as per periodic maintenance schedule.

Drive Chain (Sealed type)

- 'O' rings must always be kept wet for best performance hence lubricate at every 500 Km.
- Sealed chain lubrication can easily be done by owners using Bajaj 'Chain Lube Spray Can' available with Bajaj dealers.

Method of Sealed Chain Lubrication:

- Put vehicle on main stand. Clean the chain by using lint free cloth (If excessive mud / slush found approach BAL dealer for proper cleaning).
- Shake the can vigorously by holding vertically upright till the noise of steel ball inside heard uniformly.
- Hold spray can at the back of rear sprocket with extension tube nose at 5-10 cm.
- Rotate the wheel in reverse direction & spray the lube on middle portion of the chain up to full length of the chain.

BRAKE FLUID

pulsar N160



Front & Rear Brake Fluid Level

- Front brake fluid reservoir is located on RH side of Handle bar.
 - Rear brake fluid reservoir is located behind RH pillion holder bracket.
 - To check brake fluid level, Park the vehicle perpendicular to the ground on level surface with handle bar in straight ahead condition.
- Always ensure that brake fluid level is above 'MIN' mark given on inspection Window.
 - In case of level drop, use only DOT-4 brake fluid (from sealed container) for top up & replacement. It is advisable that brake fluid should be replaced at every 30,000 Kms.

Instruction to avail Free Service through Digitized Free Service Coupon

Please follow following procedure : -

- Please provide your mobile number to Dealer at the time of buying of new Bajaj Vehicle.
- In case of change in mobile number, please update to Dealer / ASD.
- When you are at Dealership / ASD workshop for availing Free Service, you will receive the 'Unique Coupon Number' (UCN) through SMS in your mobile.
- Please inform the UCN to Dealer / ASD at the time of Free Service.
(ASD-Authorised Service Dealer)

Periodic Service Criteria			
Service	Days	Kms	
1st Free Service	30~45	500~750	whichever occurs earlier
2nd Free Service	240	4500~5000	
3rd Free Service	360	9500~10000	
Subsequent Paid services	120 Days from last Service	Every 5000 Km after previous service	

Availing all Free / Paid Services, replacing mandatory periodic parts & engine oil will entitle warranty eligibility.



pulsar N160

PERIODIC MAINTENANCE & LUBRICATION CHART



Sr. No.	Activities / Check Points	Recommended frequency - Service interval & Kms						
		1st (Free)	2nd (Free)	3rd (Free)	4th	5th	6th	7th
		500 750	4500 5000	9500 10000	14500 15000	19500 20000	24500 25000	29500 30000
1	Servicing with water wash	✓	✓	✓	✓	✓	✓	✓
2	Engine oil (Bajaj DTSI 10000 oil)	R	Top-up	R	Top-up	R	Top-up	R
3	Oil strainer	CL		CL		CL		CL
4	Engine oil filter	R		R		R		R
5	Air cleaner element** with 'O' ring.					R		
	Drain tube cleaning.	CL	CL	CL	CL	CL	CL	CL
6	Fuel Pump Nylon hoses with quick connector					C,R		
7	Spark plug clean & check gap			CL,A		CL,A		R
8	Valve tappet clearance					C,A		
9	Engine breather tube for cracks.			C,R	C,R	C,R	C,R	C,R
10	EVAP system Hoses- check for cracks					C,R		
11	Engine oil cooler fins		C,R	C,R	C,R	C,R	C,R	C,R
12	Silencer drain hole cleaning			CL	CL	CL	CL	CL

PERIODIC MAINTENANCE & LUBRICATION CHART

Recommended frequency - Service interval & Kms									Remarks
8th	9th	10th	11th	12th	13th	14th	15th	16th	
34500 35000	39500 40000	44500 45000	49500 50000	54500 55000	59500 60000	64500 65000	69500 70000	74500 75000	
✓	✓	✓	✓	✓	✓	✓	✓	✓	Protect to prevent water entry in Petrol tank, Silencer & electrical parts. Use caustic free detergent for washing.
Top-up	R	Top-up	R	Top-up	R	Top-up	R	Top-up	Use BGO 10W40 BS6 compliant. Oil level window cleaning @ 10000 kms by petrol spray & nylon brush
	CL		CL		CL		CL		Oil strainer cleaning at the time of oil change.
	R		R		R		R		Replace oil filter during every oil change
	R				R				Replace Viscous air filter at every 20,000 kms.
CL	CL	CL	CL	CL	CL	CL	CL	CL	Replace Air filter cover 'O' ring along with air filter
	C,R				C,R				Replace if required
	CL,A		CL,A		R		CL,A		Replace at every 30000 kms
	C,A				C,A				
C,R	C,R	C,R	C,R	C,R	C,R	C,R	C,R	C,R	Replace if required. Need to remove RH Side cover. Breather Tube is visible with this cover removed.
	C,R				C,R				Drain EVAP "Y" connection drain tube. Replace if found cut/damaged
C,R	C,R	C,R	C,R	C,R	C,R	C,R	C,R	C,R	If found damaged, replace it.
CL	CL	CL	CL	CL	CL	CL	CL	CL	

PERIODIC MAINTENANCE & LUBRICATION CHART



Sr. No.	Activities / Check Points	Recommended frequency - Service interval & Kms						
		1st (Free)	2nd (Free)	3rd (Free)	4th	5th	6th	7th
		500 ~ 750	4500 ~ 5000	9500 ~ 10000	14500 ~ 15000	19500 ~ 20000	24500 ~ 25000	29500 ~ 30000
13	Wiring harness connections, routine & Conduit / PVC sleeve / Tie band inspection.	C,A,T	C,A,T	C,A,T	C,A,T	C,A,T	C,A,T	C,A,T
14	Battery connections & health by load tester. +ve terminal cap fitment.	C,A,L,T	C,A,L,T	C,A,L,T	C,A,L,T	C,A,L,T	C,A,L,T	C,A,L,T
15	Ignition switch contacts cleaning			CL,L	CL,L	CL,L	CL,L	CL,L
16	HT coil connections (Primary and Secondary)					C,T		
17	Starter motor & starter relay connections		C,T	C,T	C,T	C,T	C,T	C,T
18	Oil pressure indicator check on console post ignition ON.	C,R	C,R	C,R	C,R	C,R	C,R	C,R
19	Check fault code, Clear fault history, Update latest hex file if applicable	C	C	C	C	C	C	C
20	Sealed Drive chain wear** – Clean, lubricate & adjust. Replace if required	CL,L,A	CL,L,A	CL,L,A	CL,L,A	CL,L,A	CL,L,A	CL,L,A

PERIODIC MAINTENANCE & LUBRICATION CHART



Recommended frequency - Service interval & Kms									Remarks
8th	9th	10th	11th	12th	13th	14th	15th	16th	
34500 35000	39500 40000	44500 45000	49500 50000	54500 55000	59500 60000	64500 65000	69500 70000	74500 75000	
C,A,T	C,A,T	C,A,T	C,A,T	C,A,T	C,A,T	C,A,T	C,A,T	C,A,T	Damaged conduit / PVC sleeves protection by applying electrical tape film & ensure tie bands to specific location.
C,A,L,T	C,A,L,T	C,A,L,T	C,A,L,T	C,A,L,T	C,A,L,T	C,A,L,T	C,A,L,T	C,A,L,T	Apply petroleum jelly on battery terminals. Use Midtronics battery tester. In case of Battery removal, 1. Battery negative terminal to be disconnected first. 2. Latch seat bracket to be removed.
CL,L	CL,L	CL,L	CL,L	CL,L	CL,L	CL,L	CL,L	CL,L	Use recommended WD40 spray
	C,T				C,T				
C,T	C,T	C,T	C,T	C,T	C,T	C,T	C,T	C,T	
C,R	C,R	C,R	C,R	C,R	C,R	C,R	C,R	C,R	Icon should disappear post engine ON. After 4000 rpm, icon should not be displayed.
C	C	C	C	C	C	C	C	C	
CL,L,A	CL,L,A	CL,L,A	CL,L,A	CL,L,A	CL,L,A	CL,L,A	CL,L,A	CL,L,A	During 1st free service use OKS spray for chain cleaning without removing chain from vehicle.
									During other services clean chain with Diesel+SAE 90 oil ratio of 50:50 & lubricate by SAE 90 oil.
									Customer to use OKS chain lub spray at every 500 kms

PERIODIC MAINTENANCE & LUBRICATION CHART



Sr. No.	Activities / Check points	Recommended frequency - Service interval & Kms						
		1st (Free)	2nd (Free)	3rd (Free)	4th	5th	6th	7th
		500 ~ 750	4500 ~ 5000	9500 ~ 10000	14500 ~ 15000	19500 ~ 20000	24500 ~ 25000	29500 ~ 30000
21	Main Stand & Side stand pivot pin					CL,L		
22	Steering play	C,A	C,A	C,A	C,A	C,A	C,A	C,A
23	Steering stem bearing & Cap steering bearing (Plastic)**			C,CL,L		C,CL,L		C,CL,L
24	Front fork oil & seals	C,R	C,R	C,R	C,R	C,R	C,R	R
25	Swing arm NRB for more play							
26	Front & Rear Brake pads for wear limit.	C,R	C,R	C,R	R	C,R	C,R	R
27	1. Check source of leakages if any in the brake system.	C,A,R	C,A,R	C,A,R	C,A,R	C,A,R	C,A,R	R
	2. Check Front & rear brake hose condition.							
	3. Check Brake fluid level and top up, if needed.							
28	Rear sprocket fasteners for looseness.	C,T		C,T		C,T		C,T
29	Rear wheel rubber shock dampers for excess play.			C,R		C,R		C,R
30	Clutch & Throttle cable free play adjustment	C,A	C,A	C,A	C,A	C,A	C,A	C,A
31	Head light focus adjustment	C,A	C,A	C,A	C,A	C,A	C,A	C,A
32	Check & confirm all lights / LEDs / Switches / Horn working.	C,A	C,A	C,A	C,A	C,A	C,A	C,A

PERIODIC MAINTENANCE & LUBRICATION CHART

Recommended frequency - Service interval & Kms									Remarks
8th	9th	10th	11th	12th	13th	14th	15th	16th	
34500 35000	39500 40000	44500 45000	49500 50000	54500 55000	59500 60000	64500 65000	69500 70000	74500 75000	
	CL,L				CL,L				Use recommended AP grease.
C,A	C,A	C,A	C,A	C,A	C,A	C,A	C,A	C,A	
	C,CL,L		C,CL,L		C,CL,L		C,CL,L		Replace if required. Use Limaplex HTX3 grease for lubrication
C,R	C,R	C,R	C,R	C,R	R	C,R	C,R	C,R	Replace oil and oil seal +Dust seal in pair at every 30000kms
	L								Lubricate NRB at every 40,000 kms Use AP grease.
C,R	C,R	R	C,R	C,R	R	C,R	C,R	R	Replace at every 15000 Kms
C,A,R	C,A,R	C,A,R	C,A,R	C,A,R	R	C,A,R	C,A,R	C,A,R	Check & Top up DOT4 brake Fluid in every service.
									Replace DOT 4 brake Fluid & Master / Caliper seals at every 30000 kms
	C,T		C,T		C,T		C,T		Torque-3.5 to 3.8 Kgf-m
	C,R		C,R		C,R		C,R		Replace rear wheel rubber shock damper if required
C,A	C,A	C,A	C,A	C,A	C,A	C,A	C,A	C,A	Replace cables if operation found hard.
C,A	C,A	C,A	C,A	C,A	C,A	C,A	C,A	C,A	
C,A	C,A	C,A	C,A	C,A	C,A	C,A	C,A	C,A	Contact type switches if found sticky then use recommended WD40 spray

PERIODIC MAINTENANCE & LUBRICATION CHART



Sr. No.	Activities / Check Points	Recommended frequency - Service interval & Kms						
		1st (Free)	2nd (Free)	3rd (Free)	4th	5th	6th	7th
		500 ~ 750	4500 ~ 5000	9500 ~ 10000	14500 ~ 15000	19500 ~ 20000	24500 ~ 25000	29500 ~ 30000
33	General lubrication – Clutch lever / Rear brake pedal	C,L	C,L	C,L	C,L	C,L	C,L	C,L
34	Front & Rear Tyre air pressure.	C,A	C,A	C,A	C,A	C,A	C,A	C,A
35	Mirror position & joint firmness.	C,A	C,A	C,A	C,A	C,A	C,A	C,A
36	All fasteners tightness, few are	C,T	C,T	C,T	C,T	C,T	C,T	C,T
	1. Front & rear axle							
	2. Swing arm axle							
	3. Engine foundation							
	4. Rider foot rest							
5. Pillion Stay								
37	Mobile USB port	C,R	C,R	C,R	C,R	C,R	C,R	C,R
38	Drain hole no blockage verification below starter motor		C,CL	C,CL	C,CL	C,CL	C,CL	C,CL
39	Fuel tank water drain no blockage verification		C,CL	C,CL	C,CL	C,CL	C,CL	C,CL

****More frequent cleaning may be required while driving in dusty environment.**

C : Check, A : Adjust, CL : Clean, R : Replace, T : Tighten, L : Lubricate

Note : Periodic parts, Oil, Coolant, Filters, All types of greases, Cleaning agents, Cables, Wear & tear parts, Rubber 'O' rings / oil seals / pipes, Gaskets to be replaced as per Periodic Maintenance and Lubrication Chart are mandatory and the same are chargeable to customer.

PERIODIC MAINTENANCE & LUBRICATION CHART

Recommended frequency - Service interval & Kms									Remarks
8th	9th	10th	11th	12th	13th	14th	15th	16th	
34500 35000	39500 40000	44500 45000	49500 50000	54500 55000	59500 60000	64500 65000	69500 70000	74500 75000	
C,L	C,L	C,L	C,L	C,L	C,L	C,L	C,L	C,L	Use recommended AP grease.
C,A	C,A	C,A	C,A	C,A	C,A	C,A	C,A	C,A	Use Tyre pressure gauge
C,A	C,A	C,A	C,A	C,A	C,A	C,A	C,A	C,A	
C,T	C,T	C,T	C,T	C,T	C,T	C,T	C,T	C,T	Recommended Torque values
									Front & rear axle- 8 to 10 Kgf-m
									Swing arm axle- 13 to 15 Kgf-m
									Engine foundation Front bottom 4 to 4.2 Kgf-m, Front Top 2.8 to 3 Kgf-m, Rear- 4 to 4.2 Kgf-m Top- 2.2 to 2.4 Kgf-m
									Rider foot rest- 1.8 to 2.2 Kgf-m
Pillion stay - 1.8 to 2.2 Kgf-m									
C,R	C,R	C,R	C,R	C,R	C,R	C,R	C,R	C,R	Charging OK to be checked at Engine start condition using LED USB light
C,CL	C,CL	C,CL	C,CL	C,CL	C,CL	C,CL	C,CL	C,CL	
C,CL	C,CL	C,CL	C,CL	C,CL	C,CL	C,CL	C,CL	C,CL	

Non-use maintenance is necessary if a vehicle remains off road for a longer duration (more than 15 days**). The correct and careful non-use maintenance carried out before storing the vehicle will prevent the vehicle from rusting and from such other non-operational damages like fire hazards.

- Clean the entire vehicle thoroughly.
- Empty the fuel from the fuel tank and (if fuel is left in for a longer time, the fuel will break and gummy substance could clog the carburettor).
- Remove spark plug & put several drops of Engine oil into the cylinder. Crank engine over slowly a few times to coat cylinder wall with oil & install back spark plug.
- Set the vehicle on a box or a stand so that both wheels are raised off the ground.
- Spray oil on all unpainted metal surfaces to prevent rusting. Avoid getting oil on rubber parts or brake liners.
- Cover entire vehicle neatly. Make sure that storage area is well ventilated & free from any source of flames or spark.
- Fill 10% excess air pressure in both wheels.
- Do not apply oil on front brake disc, to prevent rusting. If the front brake disc rusts during storage, do not attempt to clean it with soap water. The rust will go off automatically during first few application of brake.

****For Battery :**

- a. Remove battery and keep it on wooden plank, in properly ventilated area.
- b. Before taking the vehicle for use.
 - Get the battery recharged from the Authorised battery / BAL dealer
 - Apply petroleum jelly on battery terminals.

Preparation for regular use after storage:

- Follow daily safety checklist mentioned on page No.22

DELIVERY CERTIFICATE



FRAME NO.:

ENGINE NO.:

Sold on.: _____

Customer's Name Mr/Mrs/Miss : _____

Address: _____ Contact No.: _____

I have taken possession of motorcycle along with the following items.

1. Owner's Manual

5. Standard Accessories

2. 2 nos of key

6. Battery

Make _____ Sr. No. _____

3. Set of tools

7. Tyre

Fr Make _____ Sr. No. _____

4. First Aid Kit

Rr Make _____ Sr. No. _____

The Vehicle has been delivered to my satisfaction & I have understood all terms and conditions of warranty, service schedules & maintenance tips and shall abide by them.

Dealer Code :

Dealer Name :

Address :

Contact No. :

Customer's Signature

(To be filled in by the dealer)

Important - Dealership should take customer sign & maintain the record of this (Delivery Certificate).

WARRANTY : SCOPE & LIMIT



Bajaj Auto Limited provides the following warranty in respect of the **"Pulsar N160 BS VI"** motorcycle manufactured by us.

Every possible care and precaution has been taken to ensure quality in respect of the material & workmanship in the vehicles manufactured by us. Bajaj Auto Limited will repair or replace at their Authorised Workshops, free of charge, part or parts there of as may be found, on examination, to have manufacturing defect within a period of 5 Years or 75,000 Kms., whichever is earlier from the date of sale subject to fulfillment of conditions stipulated in part A, B & C given here under

Note : Warranty is applicable for only first owner of vehicle.

Part A:

Warranty claims in respect of such items like shock absorbers, speedometers etc. though claimed through us, are subject to acceptance of the respective manufacturers. In all such cases the decision of the respective manufacturer will be final and binding.

Proprietary parts like tyres, tubes and battery are warranted by their respective manufacturers and should be claimed on them directly by the customer. Bajaj Auto Limited shall not be Liable to replace them though their dealer,

however Bajaj Dealers will provide full assistance in referring such claims with respective manufacturer:

Bajaj Auto Limited undertake no liability in the matter of consequential loss or damage caused due to the failure of the parts. Delay, if any, at the repairing workshop in carrying out repair to vehicle shall not be a ground for extending the warranty period, nor shall it give any right to the customer for claiming any compensation for damages.

Bajaj Auto Limited reserves the right either to repair or replace the defective parts.

Where a defective part can be replaced by part/s of alternative brand/s, which are normally used by Bajaj Auto Limited in the course of manufacture, Bajaj Auto Limited reserves the right to carry out the replacement by a part or parts of any such alternative brand/s.

This warranty and any claim arising there, is subject to Pune jurisdiction only.

Part B:

No claim for exchange or repair can be considered unless the customer :

- a. Ensures that immediately upon detection of the defect, he approaches any nearest Authorised Bajaj Vehicle Dealers & Recommended Authorised Service Dealers with the concerned vehicle and enables him

- to remove and despatch the part / parts attributing to the manufacturing defect to the Company.
- b. Produces the Owner's Manual, in original, to enable that dealer to verify the details. It must be expressly understood that claims forwarded directly to us by the owner / customer will not be entertained at all and such defective part/parts thus forwarded by them will lie at our factory at their own risk, and this warranty shall not be enforceable.

To avail benefits of warranty, following are mandatory

1. Availing of Initial 3 Free Services without lapse.
2. Availing paid services at subsequent 5000 kms. or 120 days from last service whichever is earlier without any lapse.
3. Availing of all services at the Authorised Vehicle Dealers & Recommended Authorised Service Dealers.
4. Usage of only recommended engine oil "**Bajaj DTS-I 10000 10W40**" at specified frequency for drain interval of 10,000 kms. & engine oil level top-up at 5000 kms.
5. Replacing mandatory periodic parts such as air filter, oil filter etc. as per periodic maintenance schedule.

Part C :

Further this warranty is NOT applicable to :

1. Normal maintenance operations like brake & clutch adjustments, cleaning of fuel system, engine tune-up or such other adjustments.
2. Parts subjected to normal wear & tear like Clutch Plates, Brake Shoes, Chain, Sprockets, Fork Oil Seal, Spark Plug, Control Cables, Brake Pads.
3. Replacement of bulbs & rubber components like grommets, 'O' rings, bellows as well as filters, packings, gaskets, fasteners etc.
4. Painted parts. Only blistering or peeling off of paint film are covered under warranty. Any defect arising out due to external damages or due to usage of protective covers /additional protective coatings adverse atmospheric conditions etc. are not allowed like under warranty.
5. All consumables like Engine oil, Fork oil, Brake Oil, Grease etc. are chargeable to customer.
6. Any defect arising due to above consumables not changed as per scheduled or if used other than the recommended one.
7. Never drive your bike through flooded roads or a flooded patch, as damages to the engine parts due to water entry is not covered under warranty.

8. All chrome plated parts are prone to rust or corrosion in coastal area or in acidic environment or due to neglected cleaning etc. However chrome film peeling is covered under warranty in general atmospheric conditions. Blue/ Yellow colouration of silencer near exhaust port is permissible and hence not covered under warranty.
 9. Oxidation of unpainted/painted crankcase, cylinder block, cylinder head etc. in acidic environment or in a coastal area.
 10. Parts of the vehicle that have been subjected to misuse, accident, negligent treatment OR which have been used in conjunction with parts & an equipment not manufactured or recommended for use by Bajaj Auto Limited, if found is the sole judgement of Bajaj Auto Limited, such use prematurely affects the performance and reliability of the vehicle.
 11. Parts of the vehicle that have been altered and modified or replaced in unauthorized manner like use of wider tyres, loud silencers etc and which in the sole judgement of the Bajaj Auto Limited affects its performance and reliability.
 12. **Vehicles which are not being serviced at recommended dealers as per the service schedule described or which have not been operated or maintained in accordance with the instructions maintained in the Owner's Manual.**
 13. Vehicles used for any competition or race and/or for attempting to set up any kind of record.
 14. Any failure arising due to use of adulterated or bad quality fuel.
Parts affected due to bad fuel quality are not covered Under warranty.
 15. If additional electrical accessories such as - Remote, Bigger horn, Musical brake light etc. fitted on vehicle.
 16. If the vehicle has been used for commercial purpose like Taxi or any other means of commercial transportation.
- Bajaj Auto Limited reserves the right to make any changes in design or to add any improvements on the vehicle at any time without incurring any obligation to install the same on a vehicle previously supplied and sold. Also, the conditions of this warranty are subject to alteration without any notice.
- This warranty is the entire written warranty given by Bajaj Auto Limited for "Pulsar N160 BS VI" motorcycle' and no other dealer or its or his agent or employee is authorised to extend or enlarge this warranty.

BATTERY WARRANTY CARD

MAKE OF BATTERY : MFG. CODE OF BATTERY :

BATTERY SR. NO.: BATTERY CHARGING DATE : _____

TYPE OF BATTERY : _____ VEHICLE SALE DATE : _____

NAME OF OWNER AND ADDRESS : _____

TYPE OF VEHICLE : _____ REG. NO.: _____

FRAME NO.: _____ ENGINE NO.: _____

SERVICE RECORD

Sr. No.	Date	Age Months	Voltage	Remarks	Dealer's Stamp & Signature	* Code
1						
2						
3						
4						
5						
6						

*** Code For Remarks:**

- AE:** Electrical system needs attention.
- IR:** Insufficient running of vehicle.
- CB:** Cover broken.
- BC:** Broken Container.
- PM:** Poor maintenance.
- BA:** Battery abused.

Note : Customer should insist that "Service Record" must be filled by respective authorised battery dealer as proof of specified maintenance for easy settlement of claim, if any.

USE ONLY BAJAJ GENUINE PARTS

pulsar N160



THE WORLD'S
FAVOURITE
INDIAN

Always Use
Bajaj Genuine
High Performance
Engine Oils

4T
Premium
Engine Oil

BAJAJ
10,000

10W 40



BAJAJ
10,000

10W 40



Top up
bottle

Long Drain Interval of 10,000 kms*



Reduced Friction



Clean Engine Parts,
Longer Engine Life



Smooth Clutch
Control



* Top up recommended at 5,000 kms

We are committed to provide the best of sales & service experience, however should you require any additional assistance, please call our Call centre on the number given below.



: 7219821111

Call charges are as applicable

**Call centre timings :- Monday to Sunday
(09 : 00 am - 08 : 00 pm)**



Please download customer care app from '**Google play store**' and '**Apple store**' and book the vehicles for servicing and more on your phone.

E-mail : customerservice@bajajauto.co.in

Web Site : www.bajajauto.com

CIN : L65993PN2007PLC130076